



Stiftgehäuse D-SUB - 9polig

Artikelnummer: SUHV09P

Technische Eigenschaften

Grösse:	1
Material Gehäuse:	Stahl
Oberflächenbehandlung:	Verzinkt
Werkstoff Kontakteinsatz:	Thermoplast
Betriebstemperatur:	-55°C - +105°C
Brandklasse UL94:	UL94 - V0

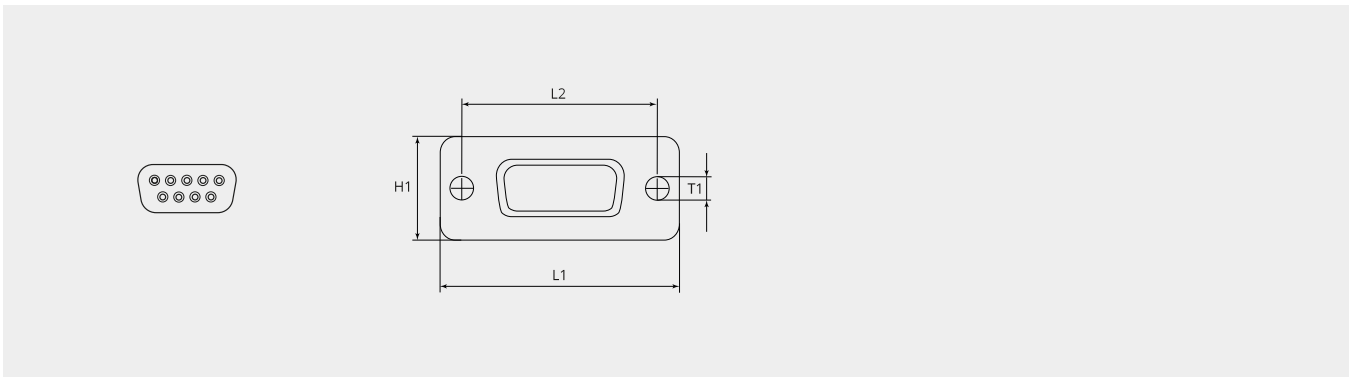

Massbild

L1 (mm):	30.8
L2 (mm):	25.0
T1 (mm):	3.0
H1 (mm):	12.5

Dazu passt:

Kontakte:

**SUMCP18-22AU1**

Gedrehte Kontaktstifte

**SUMCP18-22AU2**

Gedrehte Kontaktstifte

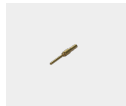
**SUMCP20-24AU1**

Gedrehte Kontaktstifte

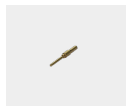
**SUMCP20-24AU2**

Gedrehte Kontaktstifte

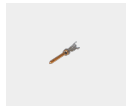
**SUPCP20-24AU2**

Gestanzte Kontaktstifte

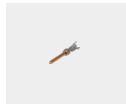
**SUPCP20-24AU2-100**

Gestanzte Kontaktstifte, Rolle à 10000 Stk.

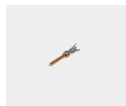
**SUPCP20-24AU2-3**

Gestanzte Kontaktstifte, Rolle à 350 Stk.

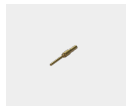
**SUMCP24-28AU1**

Gedrehte Kontaktstifte

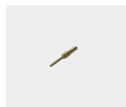
**SUMCP24-28AU2**

Gedrehte Kontaktstifte