



Tüllengehäuse Grösse 24 B

1 x M50 Gewinde seitlich, vertikal

Artikelnummer: GMRH-24BS-H-SEV-1M50

VPE: 1

Technische Eigenschaften

Material Gehäuse:	Aluminium Druckguss
Oberflächenbehandlung:	Pulverbeschichtet
Schutzschicht Farbe:	RAL 9005 (tiefschwarz)
Verriegelungsart:	Schraubverriegelung
Betriebstemperatur:	-40°C - +125°C
Material Dichtungsring:	Acrylnitril-Butadien-Kautschuk (NBR)
Anzahl Steckplätze:	6 Module
Seitlicher Kabelabgang vertikal (SEV):	1 x M50
Kabelzugentlastung:	Kabelverschraubung
REACH konform:	SVHC Stoffe, ja - Blei
ROHS konform:	Konform gemäss 2015/863/EU (RoHS II), Annex II

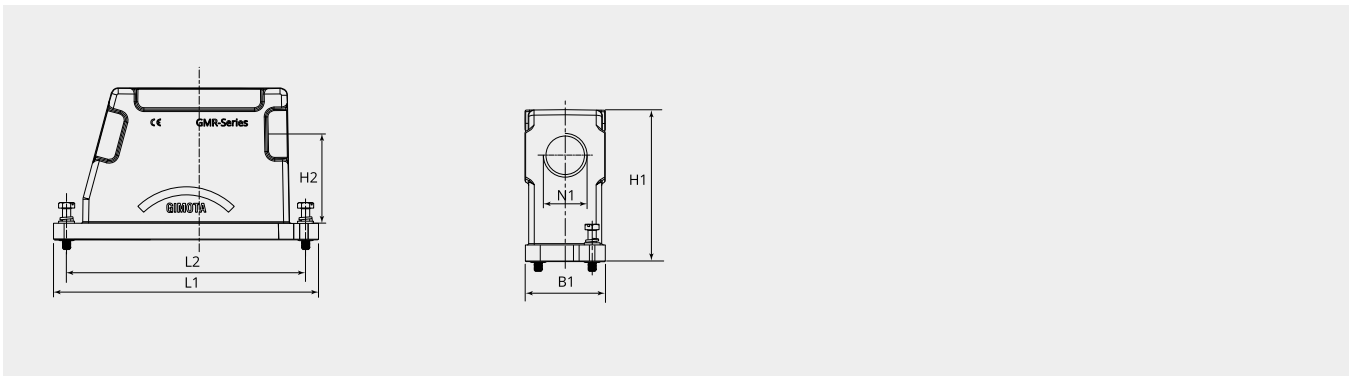

Massbild

B1 (mm):	58.0
H1 (mm):	110.0
H2 (mm):	64.8
L1 (mm):	192.0
L2 (mm):	173.0
N1:	M50x1.5



Dazu passt:

Gegenstück:



GMRH-24BS-BK-IF
Anbaugehäuse Grösse 24 B

Gelenkrahmen:



GMRS-24-3-UAF-06
Gelenkrahmen Grösse 24

Einsätze festpolig:



GMRF-250-10-108PZC-24
Festpoleinsatz 108 polig, Stift, 250V, 10A



GMRF-250-10-108SZC-24
Festpoleinsatz 108 polig, Buchse, 250V, 10A



GMRF-500-16-24PEC-24
Festpoleinsatz 24 polig, Stift, 500V, 16A



GMRF-500-16-24SEC-24
Festpoleinsatz 24 polig, Buchse, 500V, 16A



GMRF-500-16-46PEC-24
Festpoleinsatz 46 polig, Stift, 500V, 16A



GMRF-500-16-46SEC-24
Festpoleinsatz 46 polig, Buchse, 500V, 16A



GMRF-500-16-64PEC-24
Festpoleinsatz 64 polig, Stift, 500V, 16A



GMRF-500-16-64SEC-24
Festpoleinsatz 64 polig, Buchse, 500V, 16A

Kabelverschraubungen:



2900.M50N
MAXIbrass® 2900 Serie - M50x1.5